



<http://algs4.cs.princeton.edu>

3.4 HASH TABLES

- ▶ *hash functions*
- ▶ *separate chaining*
- ▶ *linear probing*
- ▶ *context*

Symbol table implementations: summary

implementation	guarantee			average case			ordered ops?	key interface
	search	insert	delete	search hit	insert	delete		
sequential search (unordered list)	N	N	N	$\frac{1}{2} N$	N	$\frac{1}{2} N$		<code>equals()</code>
binary search (ordered array)	$\lg N$	N	N	$\lg N$	$\frac{1}{2} N$	$\frac{1}{2} N$	✓	<code>compareTo()</code>
BST	N	N	N	$1.39 \lg N$	$1.39 \lg N$	\sqrt{N}	✓	<code>compareTo()</code>
red-black BST	$2 \lg N$	$2 \lg N$	$2 \lg N$	$1.0 \lg N$	$1.0 \lg N$	$1.0 \lg N$	✓	<code>compareTo()</code>

Q. Can we do better?

A. Yes, but with different access to the data.

Hashing: basic plan

Save items in a **key-indexed table** (index is a function of the key).

Hash function. Method for computing array index from key.

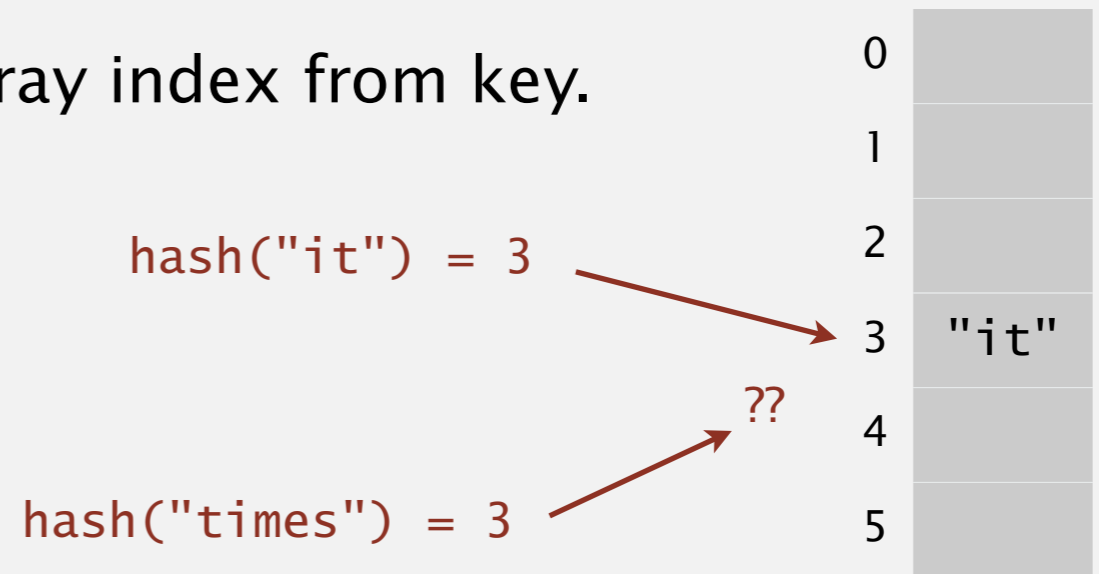

Issues.

- Computing the hash function.
- Equality test: Method for checking whether two keys are equal.
- Collision resolution: Algorithm and data structure to handle two keys that hash to the same array index.

Classic space-time tradeoff.

- No space limitation: trivial hash function with key as index.
- No time limitation: trivial collision resolution with sequential search.
- Space and time limitations: hashing (the real world).



Algorithms

ROBERT SEDGEWICK | KEVIN WAYNE

<http://algs4.cs.princeton.edu>

3.4 HASH TABLES

- ▶ *hash functions*
- ▶ *separate chaining*
- ▶ *linear probing*
- ▶ *context*

Computing the hash function

Idealistic goal. Scramble the keys uniformly to produce a table index.

- Efficiently computable.
- Each table index equally likely for each key.

thoroughly researched problem,
still problematic in practical applications

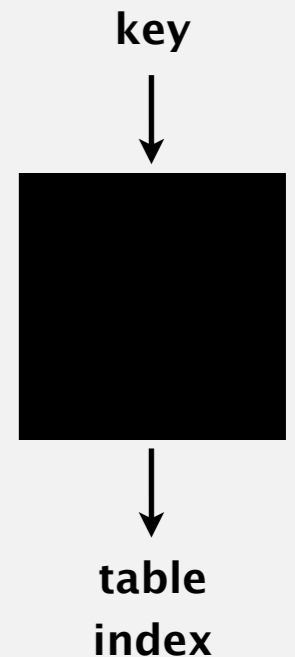

Ex 1. Phone numbers.

- Bad: first three digits.
- Better: last three digits.

Ex 2. Social Security numbers.

- Bad: first three digits.
- Better: last three digits.

573 = California, 574 = Alaska
(assigned in chronological order within geographic region)

Practical challenge. Need different approach for each key type.

Java's hash code conventions

All Java classes inherit a method `hashCode()`, which returns a 32-bit int.

Requirement. If `x.equals(y)`, then `(x.hashCode() == y.hashCode())`.

Highly desirable. If `!x.equals(y)`, then `(x.hashCode() != y.hashCode())`.

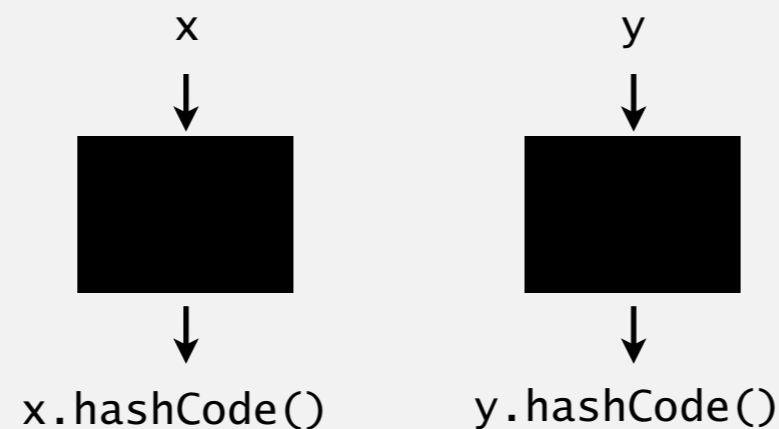

Default implementation. Memory address of `x`.

Legal (but poor) implementation. Always return 17.

Customized implementations. Integer, Double, String, File, URL, Date, ...

User-defined types. Users are on their own.

Implementing hash code: integers, booleans, and doubles

Java library implementations

```
public final class Integer
{
    private final int value;
    ...

    public int hashCode()
    { return value; }
}
```

```
public final class Boolean
{
    private final boolean value;
    ...

    public int hashCode()
    {
        if (value) return 1231;
        else      return 1237;
    }
}
```

```
public final class Double
{
    private final double value;
    ...

    public int hashCode()
    {
        long bits = doubleToLongBits(value);
        return (int) (bits ^ (bits >>> 32));
    }
}
```

convert to IEEE 64-bit representation;
xor most significant 32-bits
with least significant 32-bits

Warning: -0.0 and +0.0 have different hash codes

Implementing hash code: strings

Java library implementation

```
public final class String
{
    private final char[] s;
    ...

    public int hashCode()
    {
        int hash = 0;
        for (int i = 0; i < length(); i++)
            hash = s[i] + (31 * hash);
        return hash;
    }
}
```

*j*th character of s

char	Unicode
...	...
'a'	97
'b'	98
'c'	99
...	...

- Horner's method to hash string of length L : L multiplies/adds.
- Equivalent to $h = s[0] \cdot 31^{L-1} + \dots + s[L-3] \cdot 31^2 + s[L-2] \cdot 31^1 + s[L-1] \cdot 31^0$.

Ex.

```
String s = "call";
int code = s.hashCode();
```

← $3045982 = 99 \cdot 31^3 + 97 \cdot 31^2 + 108 \cdot 31^1 + 108 \cdot 31^0$
 $= 108 + 31 \cdot (108 + 31 \cdot (97 + 31 \cdot (99)))$
(Horner's method)

Implementing hash code: strings

Performance optimization.

- Cache the hash value in an instance variable.
- Return cached value.

```
public final class String
{
    private int hash = 0;
    private final char[] s;
    ...

    public int hashCode()
    {
        int h = hash;
        if (h != 0) return h;
        for (int i = 0; i < length(); i++)
            h = s[i] + (31 * h);
        hash = h;
        return h;
    }
}
```

← cache of hash code

← return cached value

← store cache of hash code

Q. What if hashCode() of string is 0?

Implementing hash code: user-defined types

```
public final class Transaction implements Comparable<Transaction>
{
    private final String who;
    private final Date when;
    private final double amount;

    public Transaction(String who, Date when, double amount)
    { /* as before */ }

    ...

    public boolean equals(Object y)
    { /* as before */ }
```

```
public int hashCode()
{
    int hash = 17;
    hash = 31*hash + who.hashCode();
    hash = 31*hash + when.hashCode();
    hash = 31*hash + ((Double) amount).hashCode();
    return hash;
}
```

nonzero constant

for reference types,
use hashCode()

for primitive types,
use hashCode()
of wrapper type

typically a small prime

Hash code design

"Standard" recipe for user-defined types.

- Combine each significant field using the $31x + y$ rule.
- If field is a primitive type, use wrapper type `hashCode()`.
- If field is `null`, return 0.
- If field is a reference type, use `hashCode()`. ← applies rule recursively
- If field is an array, apply to each entry. ← or use `Arrays.deepHashCode()`

In practice. Recipe works reasonably well; used in Java libraries.

In theory. Keys are bitstring; "universal" hash functions exist.

Basic rule. Need to use the whole key to compute hash code; consult an expert for state-of-the-art hash codes.

Modular hashing

Hash code. An int between -2^{31} and $2^{31} - 1$.

Hash function. An int between 0 and $M - 1$ (for use as array index).

typically a prime or power of 2

```
private int hash(Key key)
{ return key.hashCode() % M; }
```

bug

```
private int hash(Key key)
{ return Math.abs(key.hashCode()) % M; }
```

1-in-a-billion bug

hashCode() of "polygenelubricants" is -2^{31}

```
private int hash(Key key)
{ return (key.hashCode() & 0x7fffffff) % M; }
```

correct

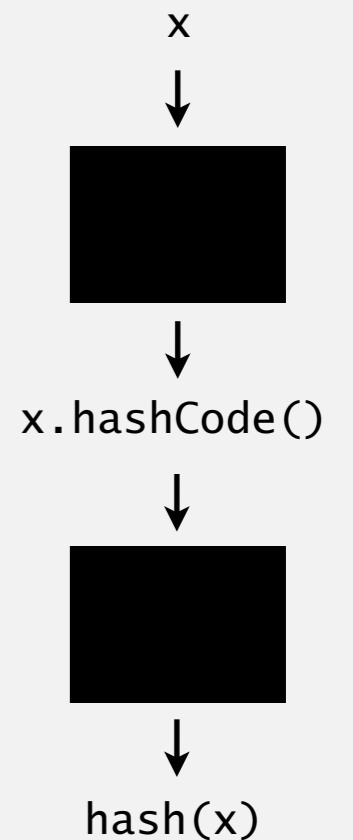

Uniform hashing assumption

Uniform hashing assumption. Each key is equally likely to hash to an integer between 0 and $M - 1$.

Bins and balls. Throw balls uniformly at random into M bins.

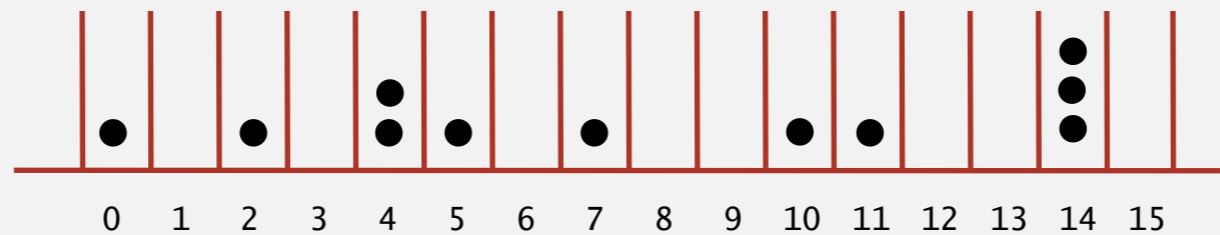

Birthday problem. Expect two balls in the same bin after $\sim \sqrt{\pi M / 2}$ tosses.

Coupon collector. Expect every bin has ≥ 1 ball after $\sim M \ln M$ tosses.

Load balancing. After M tosses, expect most loaded bin has $\Theta(\log M / \log \log M)$ balls.

Uniform hashing assumption

Uniform hashing assumption. Each key is equally likely to hash to an integer between 0 and $M - 1$.

Bins and balls. Throw balls uniformly at random into M bins.

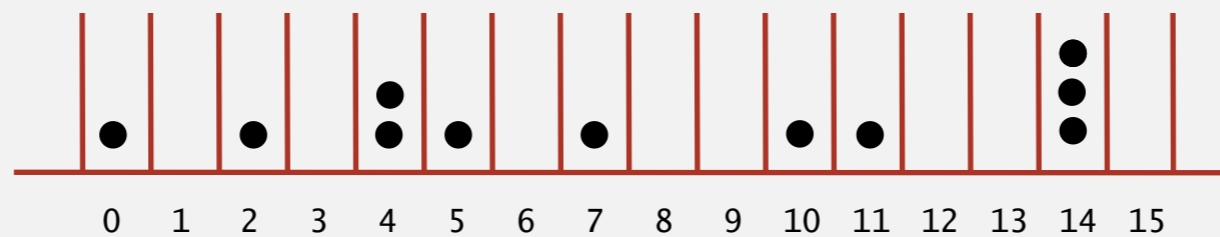

Java's String data uniformly distribute the keys of Tale of Two Cities



Algorithms

ROBERT SEDGEWICK | KEVIN WAYNE

<http://algs4.cs.princeton.edu>

3.4 HASH TABLES

- ▶ *hash functions*
- ▶ *separate chaining*
- ▶ *linear probing*
- ▶ *context*

Collisions

Collision. Two distinct keys hashing to same index.

- Birthday problem \Rightarrow can't avoid collisions unless you have a ridiculous (quadratic) amount of memory.
- Coupon collector + load balancing \Rightarrow collisions are evenly distributed.

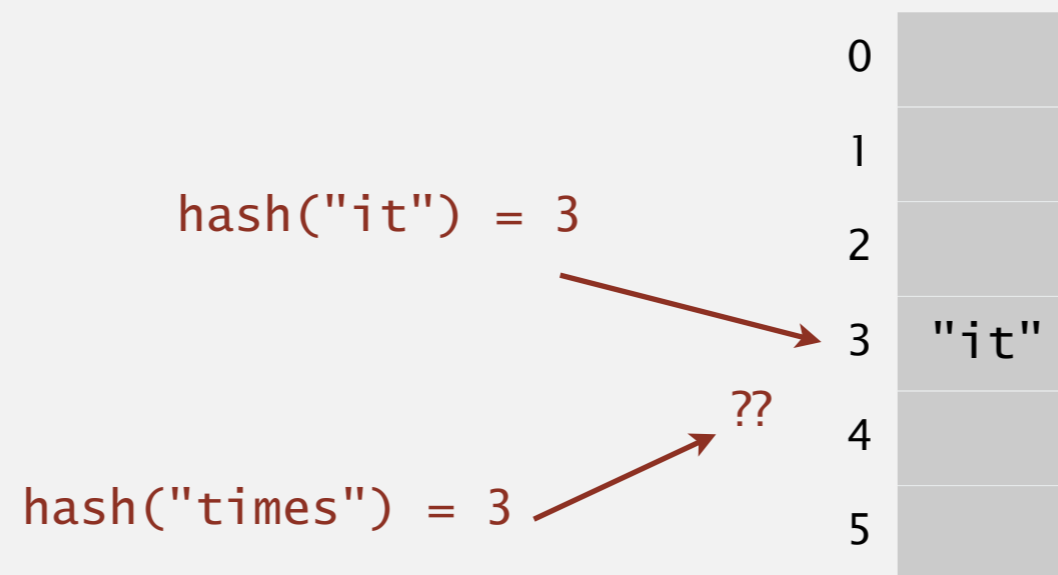

Challenge. Deal with collisions efficiently.

Separate-chaining symbol table

Use an array of $M < N$ linked lists. [H. P. Luhn, IBM 1953]

- Hash: map key to integer i between 0 and $M - 1$.
- Insert: put at front of i^{th} chain (if not already there).
- Search: need to search only i^{th} chain.

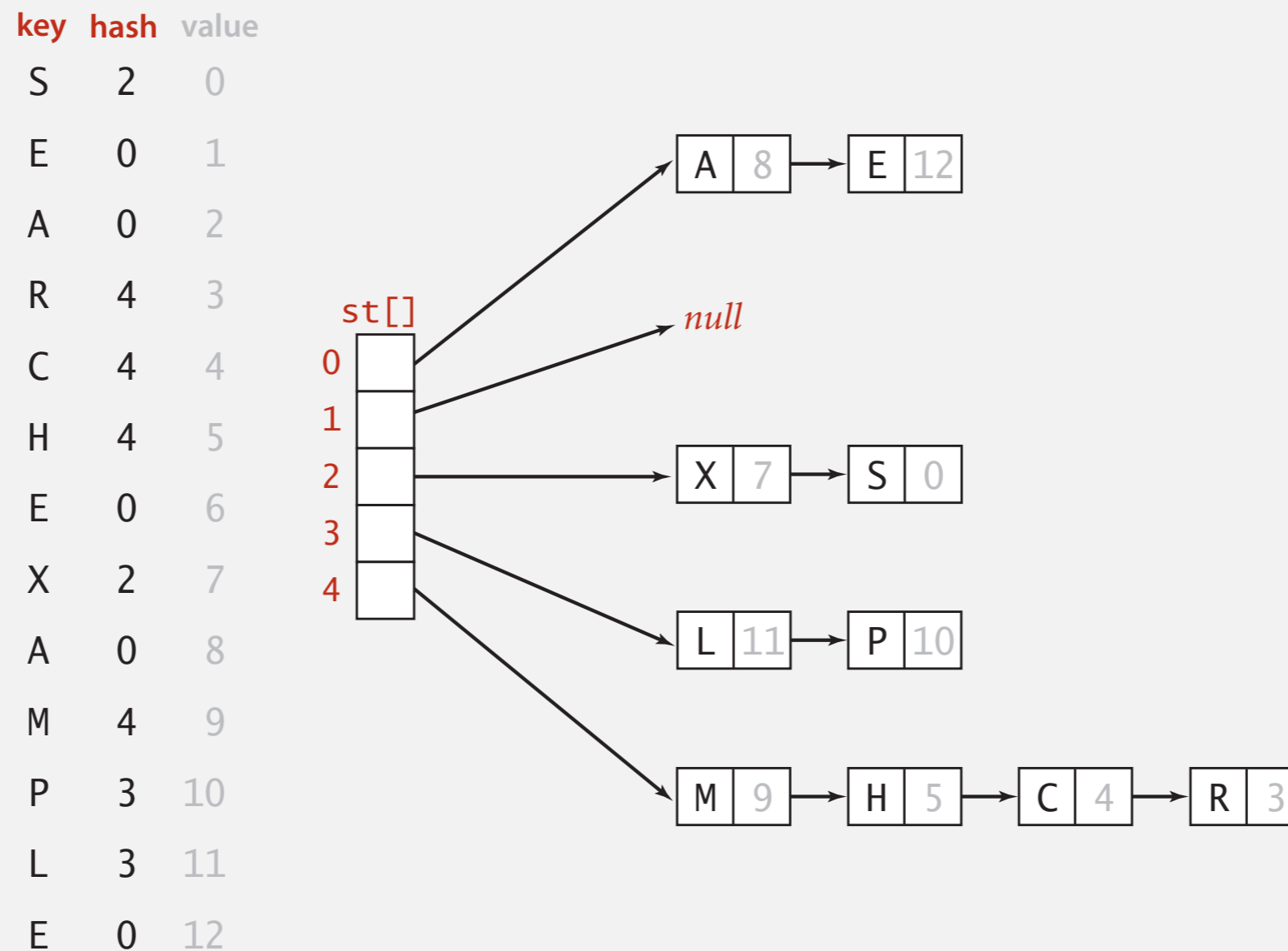

Separate-chaining symbol table: Java implementation

```
public class SeparateChainingHashST<Key, Value>
{
    private int M = 97;           // number of chains
    private Node[] st = new Node[M]; // array of chains

    private static class Node
    {
        private Object key;
        private Object val;
        private Node next;
        ...
    }

    private int hash(Key key)
    { return (key.hashCode() & 0x7fffffff) % M; }

    public Value get(Key key) {
        int i = hash(key);
        for (Node x = st[i]; x != null; x = x.next)
            if (key.equals(x.key)) return (Value) x.val;
        return null;
    }
}
```

array doubling and
halving code omitted

no generic array creation
(declare key and value of type Object)

Separate-chaining symbol table: Java implementation

```
public class SeparateChainingHashST<Key, Value>
{
    private int M = 97;           // number of chains
    private Node[] st = new Node[M]; // array of chains

    private static class Node
    {
        private Object key;
        private Object val;
        private Node next;
        ...
    }

    private int hash(Key key)
    { return (key.hashCode() & 0x7fffffff) % M; }

    public void put(Key key, Value val) {
        int i = hash(key);
        for (Node x = st[i]; x != null; x = x.next)
            if (key.equals(x.key)) { x.val = val; return; }
        st[i] = new Node(key, val, st[i]);
    }
}
```

Resizing in a separate-chaining hash table

Goal. Average length of list $N/M = \text{constant}$.

- Double size of array M when $N/M \geq 8$.
- Halve size of array M when $N/M \leq 2$.
- Need to rehash all keys when resizing. ← $x.\text{hashCode}()$ does not change but $\text{hash}(x)$ can change

before resizing

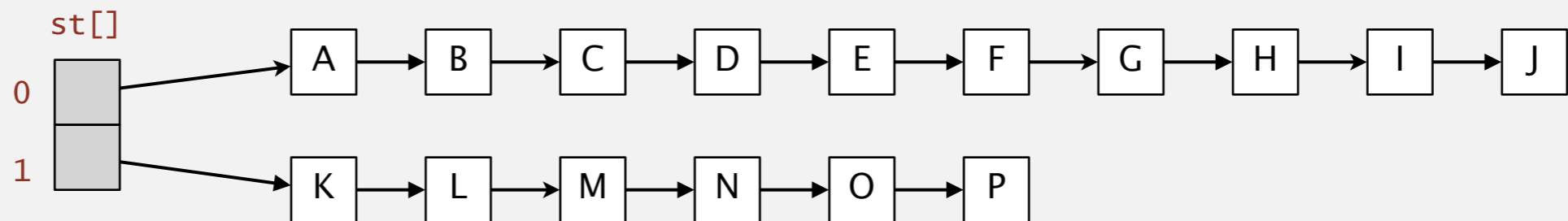

after resizing

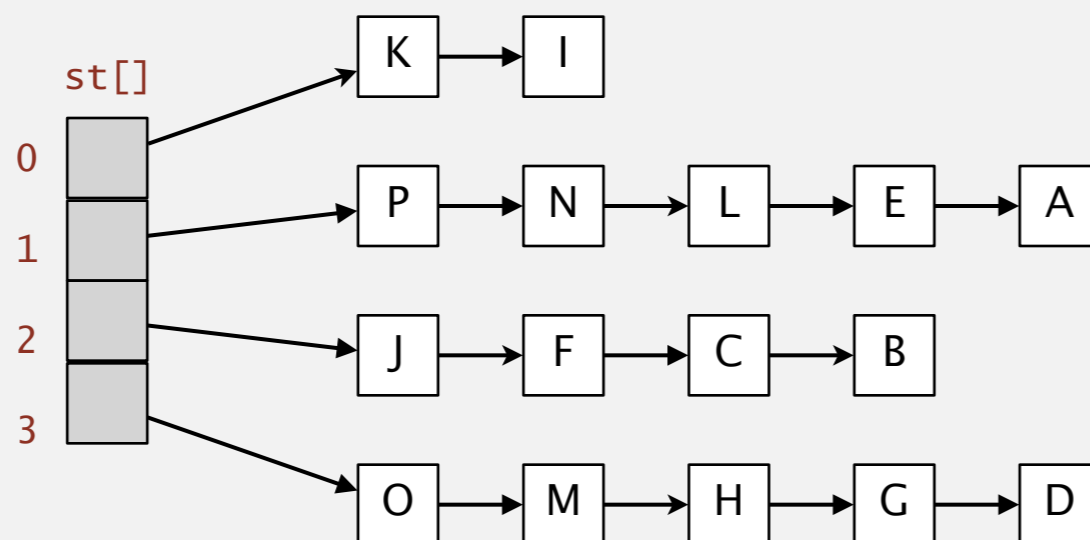

Deletion in a separate-chaining hash table

Q. How to delete a key (and its associated value)?

A. Easy: need only consider chain containing key.

before deleting C

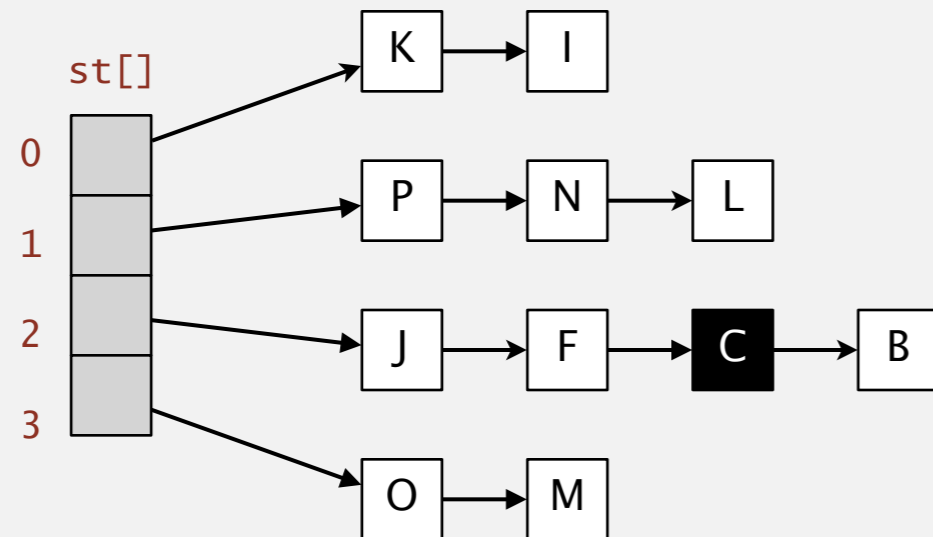

after deleting C

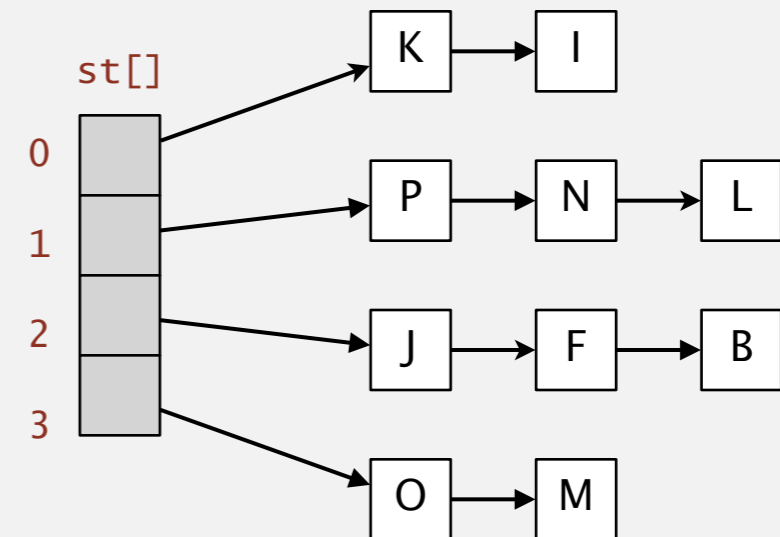

Symbol table implementations: summary

implementation	guarantee			average case			ordered ops?	key interface
	search	insert	delete	search hit	insert	delete		
sequential search (unordered list)	N	N	N	$\frac{1}{2} N$	N	$\frac{1}{2} N$		<code>equals()</code>
binary search (ordered array)	$\lg N$	N	N	$\lg N$	$\frac{1}{2} N$	$\frac{1}{2} N$	✓	<code>compareTo()</code>
BST	N	N	N	$1.39 \lg N$	$1.39 \lg N$	\sqrt{N}	✓	<code>compareTo()</code>
red-black BST	$2 \lg N$	$2 \lg N$	$2 \lg N$	$1.0 \lg N$	$1.0 \lg N$	$1.0 \lg N$	✓	<code>compareTo()</code>
separate chaining	N	N	N	$3-5 *$	$3-5 *$	$3-5 *$		<code>equals()</code> <code>hashCode()</code>

* under uniform hashing assumption



<http://algs4.cs.princeton.edu>

3.4 HASH TABLES

- ▶ *hash functions*
- ▶ *separate chaining*
- ▶ *linear probing*
- ▶ *context*

Collision resolution: open addressing

Open addressing. [Amdahl-Boehme-Rochester-Samuel, IBM 1953]

When a new key collides, find next empty slot, and put it there.

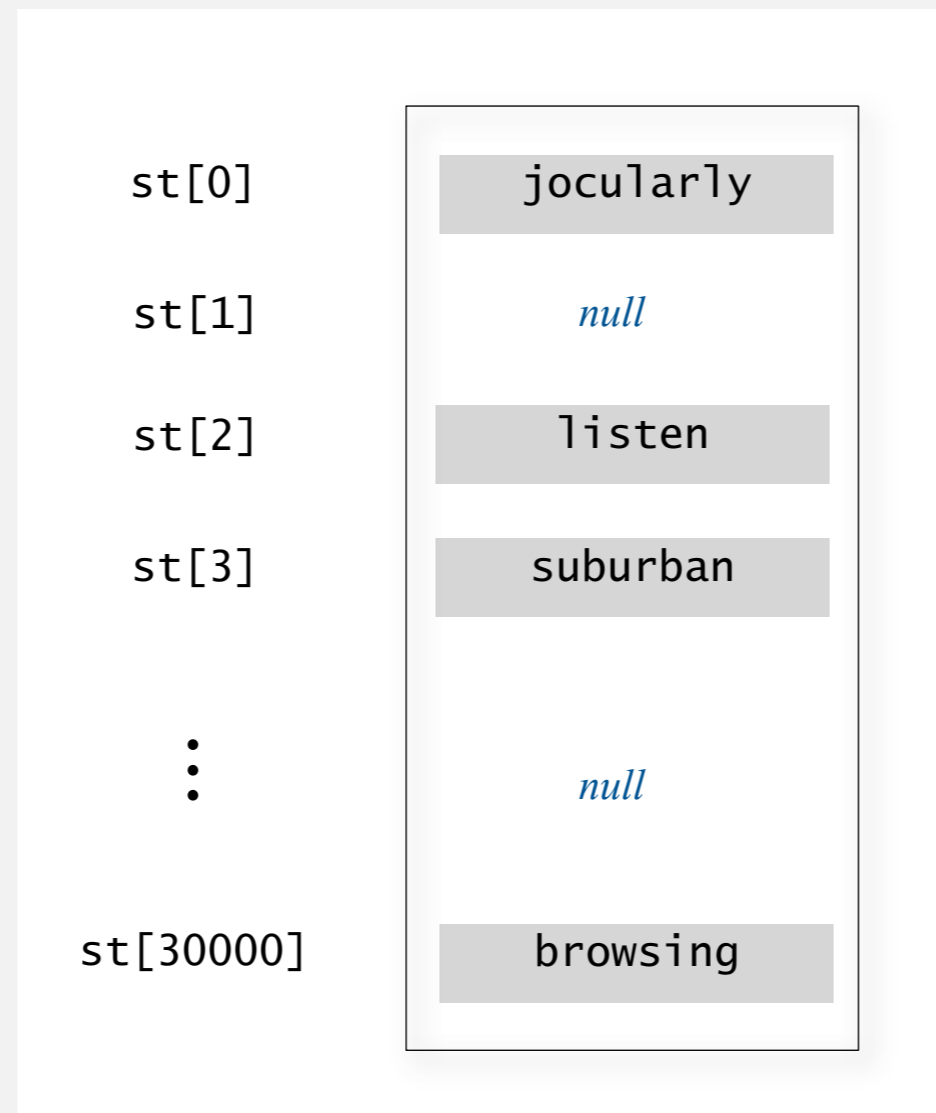

linear probing ($M = 30001$, $N = 15000$)

Linear-probing hash table demo

Hash. Map key to integer i between 0 and $M-1$.

Insert. Put at table index i if free; if not try $i+1$, $i+2$, etc.

linear-probing hash table

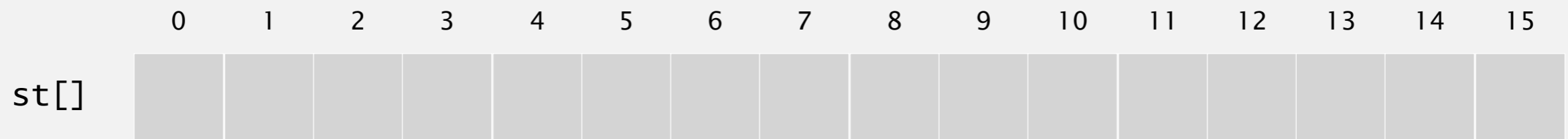

$M = 16$



Linear-probing hash table demo

Hash. Map key to integer i between 0 and $M-1$.

Search. Search table index i ; if occupied but no match, try $i+1$, $i+2$, etc.

search K
hash(K) = 5

	0	1	2	3	4	5	6	7	8	9	10	11	12	13	14	15
st[]	P	M			A	C	S	H	L		E				R	X

M = 16

K

search miss
(return null)

Linear-probing hash table summary

Hash. Map key to integer i between 0 and $M-1$.

Insert. Put at table index i if free; if not try $i+1$, $i+2$, etc.

Search. Search table index i ; if occupied but no match, try $i+1$, $i+2$, etc.

Note. Array size M **must be** greater than number of key-value pairs N .

	0	1	2	3	4	5	6	7	8	9	10	11	12	13	14	15
st[]	P	M			A	C	S	H	L		E				R	X

$M = 16$

Linear-probing symbol table: Java implementation

```
public class LinearProbingHashST<Key, Value>
{
    private int M = 30001;
    private Value[] vals = (Value[]) new Object[M];
    private Key[] keys = (Key[]) new Object[M];

    private int hash(Key key) { /* as before */ }

    private void put(Key key, Value val) { /* next slide */ }

    public Value get(Key key)
    {
        for (int i = hash(key); keys[i] != null; i = (i+1) % M)
            if (key.equals(keys[i]))
                return vals[i];
        return null;
    }
}
```

array doubling and
halving code omitted



Linear-probing symbol table: Java implementation

```
public class LinearProbingHashST<Key, Value>
{
    private int M = 30001;
    private Value[] vals = (Value[]) new Object[M];
    private Key[] keys = (Key[]) new Object[M];

    private int hash(Key key) { /* as before */ }

    private Value get(Key key) { /* previous slide */ }

    public void put(Key key, Value val)
    {
        int i;
        for (i = hash(key); keys[i] != null; i = (i+1) % M)
            if (keys[i].equals(key))
                break;
        keys[i] = key;
        vals[i] = val;
    }
}
```

Clustering

Cluster. A contiguous block of items.

Observation. New keys likely to hash into middle of big clusters.

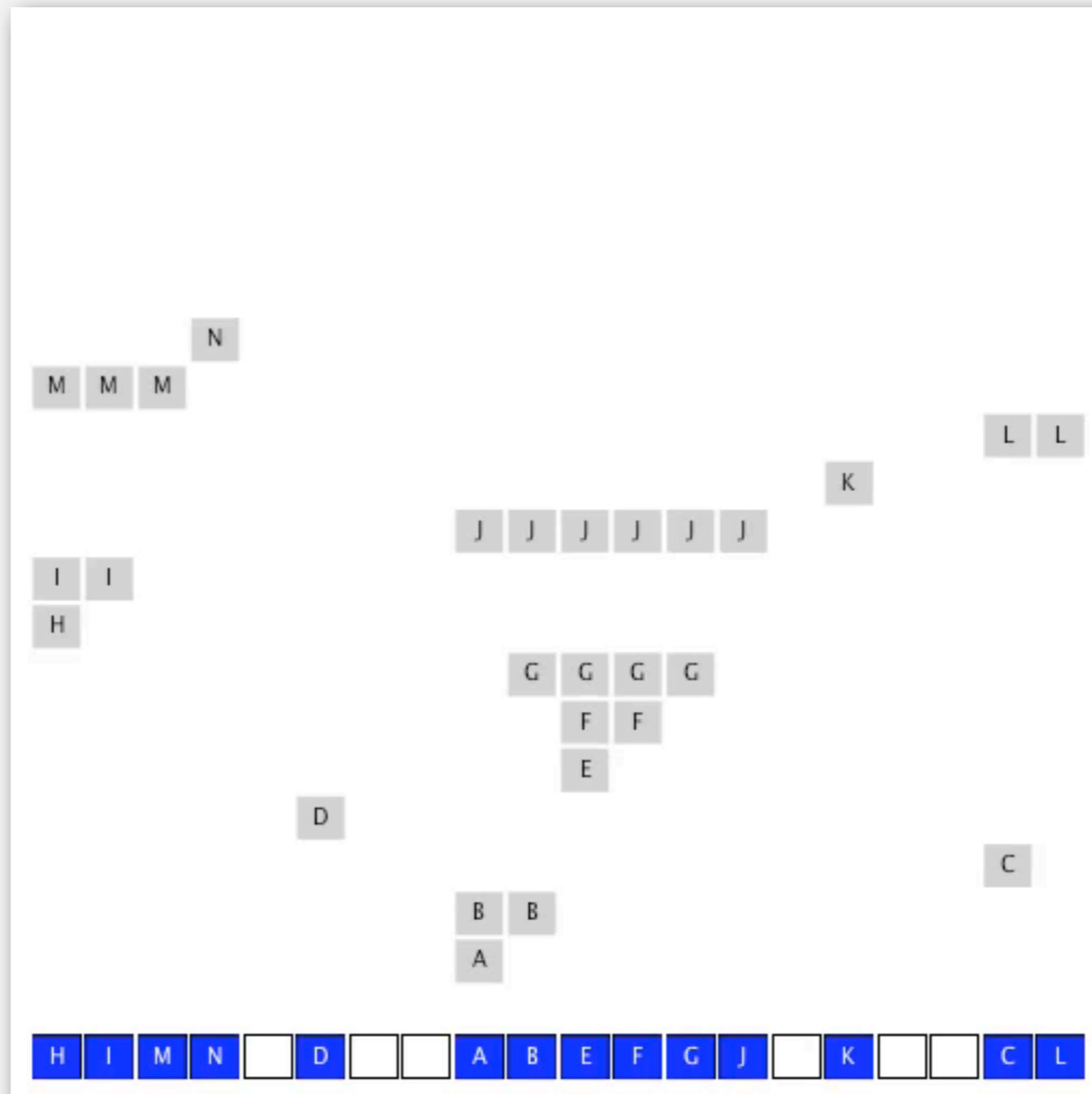

Knuth's parking problem

Model. Cars arrive at one-way street with M parking spaces.

Each desires a random space i : if space i is taken, try $i + 1, i + 2, \text{etc.}$

Q. What is mean displacement of a car?

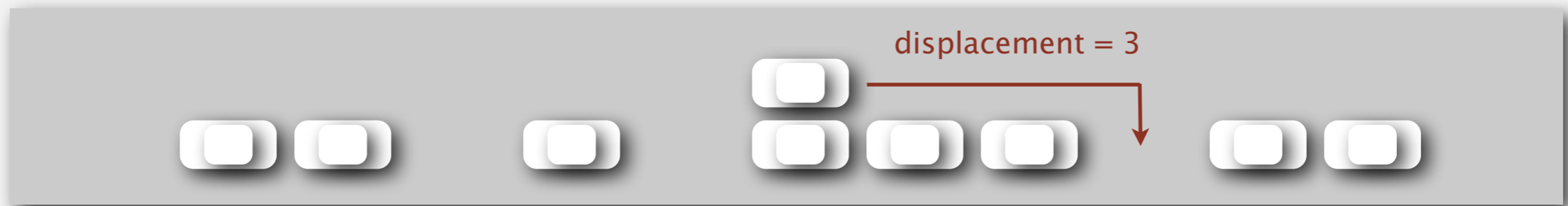

Half-full. With $M/2$ cars, mean displacement is $\sim 3/2$.

Full. With M cars, mean displacement is $\sim \sqrt{\pi M/8}$.

Analysis of linear probing

Proposition. Under uniform hashing assumption, the average # of probes in a linear probing hash table of size M that contains $N = \alpha M$ keys is:

$$\sim \frac{1}{2} \left(1 + \frac{1}{1 - \alpha} \right) \quad \sim \frac{1}{2} \left(1 + \frac{1}{(1 - \alpha)^2} \right)$$

search hit search miss / insert

Pf.

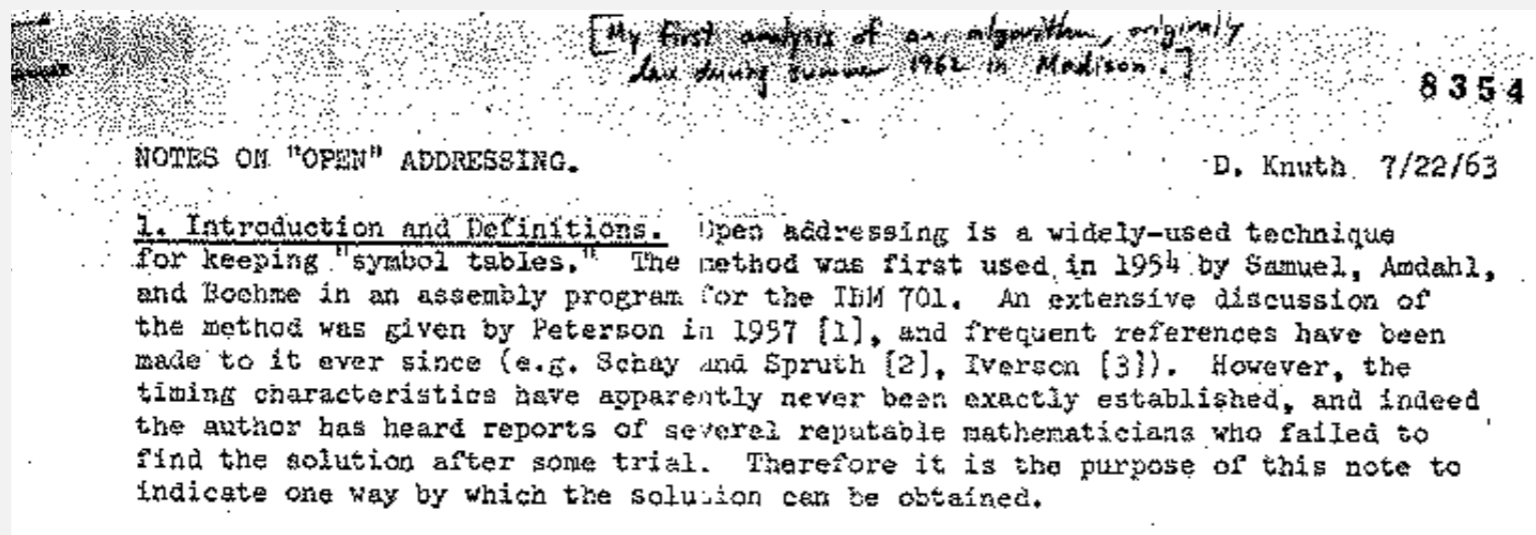

Parameters.

- M too large \Rightarrow too many empty array entries.
- M too small \Rightarrow search time blows up.
- Typical choice: $\alpha = N / M \sim 1/2$. ← # probes for search hit is about 3/2
probes for search miss is about 5/2

Resizing in a linear-probing hash table

Goal. Average length of list $N / M \leq 1/2$.

- Double size of array M when $N / M \geq 1/2$.
- Halve size of array M when $N / M \leq 1/8$.
- Need to rehash all keys when resizing.

before resizing

	0	1	2	3	4	5	6	7
keys[]		E	S			R	A	
vals[]		1	0			3	2	

after resizing

	0	1	2	3	4	5	6	7	8	9	10	11	12	13	14	15
keys[]					A		S				E				R	
vals[]					2		0				1				3	

Deletion in a linear-probing hash table

Q. How to delete a key (and its associated value)?

A. Requires some care: can't just delete array entries.

before deleting S

	0	1	2	3	4	5	6	7	8	9	10	11	12	13	14	15
keys[]	P	M			A	C	S	H	L		E				R	X
vals[]	10	9			8	4	0	5	11		12				3	7

doesn't work, e.g., if $\text{hash}(H) = 4$

after deleting S ?

	0	1	2	3	4	5	6	7	8	9	10	11	12	13	14	15
keys[]	P	M			A	C		H	L		E				R	X
vals[]	10	9			8	4		5	11		12				3	7

ST implementations: summary

implementation	guarantee			average case			ordered ops?	key interface
	search	insert	delete	search hit	insert	delete		
sequential search (unordered list)	N	N	N	$\frac{1}{2} N$	N	$\frac{1}{2} N$		<code>equals()</code>
binary search (ordered array)	$\lg N$	N	N	$\lg N$	$\frac{1}{2} N$	$\frac{1}{2} N$	✓	<code>compareTo()</code>
BST	N	N	N	$1.39 \lg N$	$1.39 \lg N$	\sqrt{N}	✓	<code>compareTo()</code>
red-black BST	$2 \lg N$	$2 \lg N$	$2 \lg N$	$1.0 \lg N$	$1.0 \lg N$	$1.0 \lg N$	✓	<code>compareTo()</code>
separate chaining	N	N	N	$3-5 *$	$3-5 *$	$3-5 *$		<code>equals()</code> <code>hashCode()</code>
linear probing	N	N	N	$3-5 *$	$3-5 *$	$3-5 *$		<code>equals()</code> <code>hashCode()</code>

* under uniform hashing assumption



Algorithms

ROBERT SEDGEWICK | KEVIN WAYNE

<http://algs4.cs.princeton.edu>

3.4 HASH TABLES

- ▶ *hash functions*
- ▶ *separate chaining*
- ▶ *linear probing*
- ▶ **context**

War story: algorithmic complexity attacks

Q. Is the uniform hashing assumption important in practice?

A. Obvious situations: aircraft control, nuclear reactor, pacemaker.

A. Surprising situations: **denial-of-service** attacks.

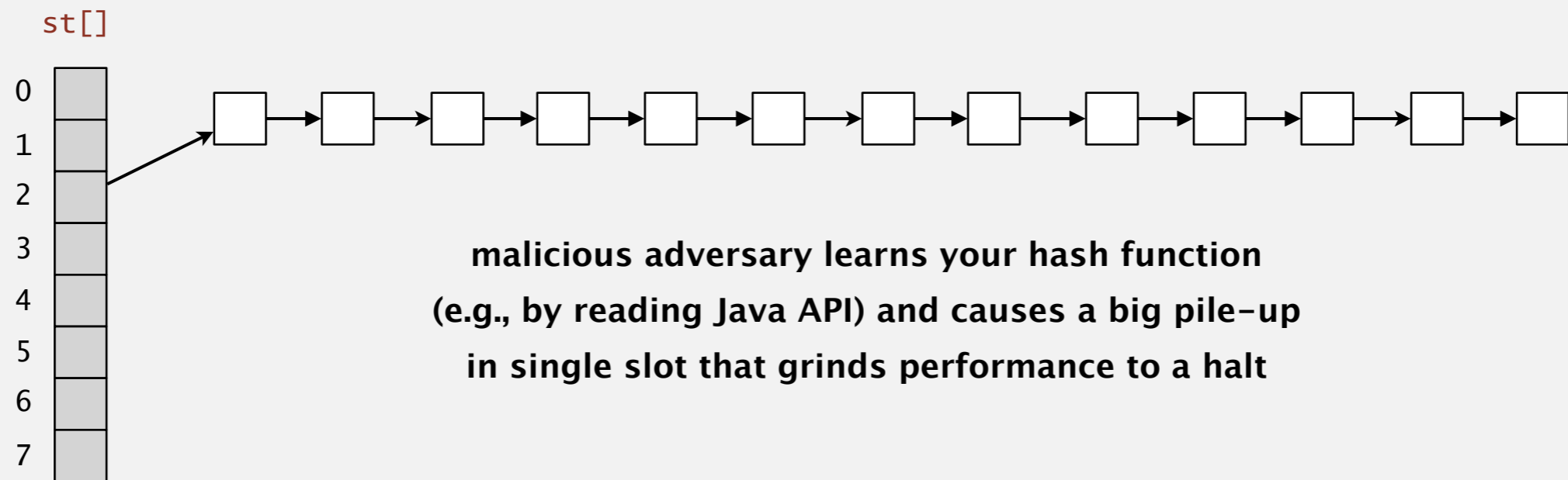

Real-world exploits. [Crosby-Wallach 2003]

- Bro server: send carefully chosen packets to DOS the server, using less bandwidth than a dial-up modem.
- Perl 5.8.0: insert carefully chosen strings into associative array.
- Linux 2.4.20 kernel: save files with carefully chosen names.

War story: algorithmic complexity attacks

A Java bug report.

Jan Lieskovsky 2011-11-01 10:13:47 EDT

Description

Julian Wälde and Alexander Klink reported that the `String.hashCode()` hash function is not sufficiently collision resistant. `hashCode()` value is used in the implementations of `HashMap` and `Hashtable` classes:

<http://docs.oracle.com/javase/6/docs/api/java/util/HashMap.html>

<http://docs.oracle.com/javase/6/docs/api/java/util/Hashtable.html>

A specially-crafted set of keys could trigger hash function collisions, which can degrade performance of `HashMap` or `Hashtable` by changing hash table operations complexity from an expected/average $O(1)$ to the worst case $O(n)$. Reporters were able to find colliding strings efficiently using equivalent substrings and meet in the middle techniques.

This problem can be used to start a denial of service attack against Java applications that use untrusted inputs as `HashMap` or `Hashtable` keys. An example of such application is web application server (such as tomcat, see [bug #750521](#)) that may fill hash tables with data from HTTP request (such as GET or POST parameters). A remote attack could use that to make JVM use excessive amount of CPU time by sending a POST request with large amount of parameters which hash to the same value.

This problem is similar to the issue that was previously reported for and fixed in e.g. perl:

http://www.cs.rice.edu/~scrosby/hash/CrosbyWallach_UsenixSec2003.pdf

Algorithmic complexity attack on Java

Goal. Find family of strings with the same hash code.

Solution. The base-31 hash code is part of Java's string API.

key	hashCode()
"Aa"	2112
"BB"	2112

key	hashCode()
"AaAaAaAa"	-540425984
"AaAaAaBB"	-540425984
"AaAaBBaA"	-540425984
"AaAaBBBB"	-540425984
"AaBBaAaA"	-540425984
"AaBBaABB"	-540425984
"AaBBBBaA"	-540425984
"AaBBBBBB"	-540425984

key	hashCode()
"BBaAaAaA"	-540425984
"BBaAaABB"	-540425984
"BBaABBAa"	-540425984
"BBaBBBBB"	-540425984
"BBBBaAaA"	-540425984
"BBBBaABB"	-540425984
"BBBBBBaA"	-540425984
"BBBBBBBB"	-540425984

2^N strings of length $2N$ that hash to same value!

Diversion: one-way hash functions

One-way hash function. "Hard" to find a key that will hash to a desired value (or two keys that hash to same value).

Ex. MD4, MD5, SHA-0, SHA-1, SHA-2, WHIRLPOOL, RIPEMD-160,



```
String password = args[0];
MessageDigest sha1 = MessageDigest.getInstance("SHA1");
byte[] bytes = sha1.digest(password);

/* prints bytes as hex string */
```

Applications. Digital fingerprint, message digest, storing passwords.

Caveat. Too expensive for use in ST implementations.

Separate chaining vs. linear probing

Separate chaining.

- Performance degrades gracefully.
- Clustering less sensitive to poorly-designed hash function.

Linear probing.

- Less wasted space.
- Better cache performance.

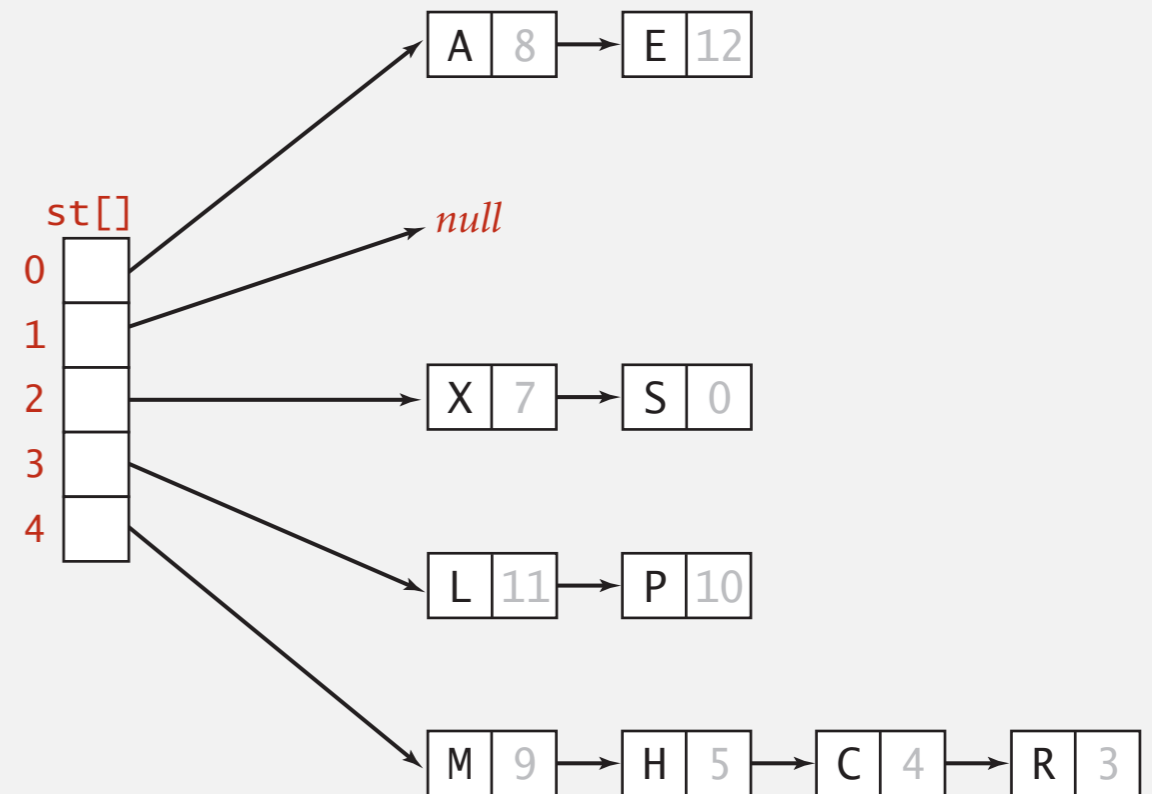

	0	1	2	3	4	5	6	7	8	9	10	11	12	13	14	15
<code>keys[]</code>	P	M			A	C	S	H	L		E				R	X
<code>vals[]</code>	10	9			8	4	0	5	11		12				3	7

Hashing: variations on the theme

Many improved versions have been studied.

Two-probe hashing. [separate-chaining variant]

- Hash to two positions, insert key in shorter of the two chains.
- Reduces expected length of the longest chain to $\log \log N$.

Double hashing. [linear-probing variant]

- Use linear probing, but skip a variable amount, not just 1 each time.
- Effectively eliminates clustering.
- Can allow table to become nearly full.
- More difficult to implement delete.

Cuckoo hashing. [linear-probing variant]

- Hash key to two positions; insert key into either position; if occupied, reinsert displaced key into its alternative position (and recur).
- Constant worst-case time for search.

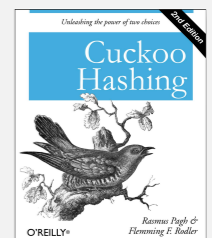

Hash tables vs. balanced search trees

Hash tables.

- Simpler to code.
- No effective alternative for unordered keys.
- Faster for simple keys (a few arithmetic ops versus $\log N$ compares).
- Better system support in Java for strings (e.g., cached hash code).

Balanced search trees.

- Stronger performance guarantee.
- Support for ordered ST operations.
- Easier to implement `compareTo()` correctly than `equals()` and `hashCode()`.

Java system includes both.

- Red-black BSTs: `java.util.TreeMap`, `java.util.TreeSet`.
- Hash tables: `java.util.HashMap`, `java.util.IdentityHashMap`.